

USER'S MANUAL

# WINDOW TYPE AIR CONDITION

ASW-09BI, ASW-12BI



# Explanation of Symbols

---



**DANGER**

Indicates a hazardous situation that, if not avoided, will result in death or serious injury.



**WARNING**

Indicates a hazardous situation that, if not avoided, could result in death or serious injury.



**CAUTION**

Indicates a hazardous situation that, if not avoided, may result in minor or moderate injury.

***NOTICE***

Indicates important but not hazard-related information, used to indicate risk of property damage.



Indicates a hazard that would be assigned a signal word **WARNING** or **CAUTION**.

# CONTENTS

Thank you for choosing air conditioner. Our design is based on the best efficiency and the lowest noise operation and it can keep the room comfortable. Please read this operating manual carefully before operating the unit and keep it for consultation.

## Structure mechanism and Installation

The Refrigerant	1
Precautions	2
Installation	3
Notes for installation	6
Function	7
Power requirement	8

## Operation procedure

Part identification	9
Air direction adjustment	9
Remote control operation procedure	10
Introduction for icons on display screen	10
Introduction for buttons on remote controller	11
Remote control panel	15
Operation Tips	16

## Care and maintenance

Caution	17
Care and maintenance	19
Troubleshooting guide	20
After service	21
Safety operation of flammable refrigerant	22

This appliance is not intended for use by persons (including children) with reduced physical, sensory or mental capabilities, or lack of experience and knowledge, unless they have been given supervision or instruction concerning use of the appliance by a person responsible for their safety. Children should be supervised to ensure that they do not play with the appliance.



This marking indicates that this product should not be disposed with other household wastes throughout the EU. To prevent possible harm to the environment or human health from uncontrolled waste disposal, recycle it responsibly to promote the sustainable reuse of material resources. To return your used device, please use the return and collection systems or contact the retailer where the product was purchased. They can take this product for environmental safe recycling.

---

Please read this operating manual carefully before operating the unit.



Appliance filled with flammable gas R32.



Before use the appliance, read the owner's manual first.



Before install the appliance, read the installation manual first.



Before repair the appliance, read the service manual first.

The figures in this manual may be different with the material objects, please refer to the material objects for reference.

## ● The Refrigerant

- To realize the function of the air conditioner unit, a special refrigerant circulates in the system. The used refrigerant is the fluoride R32, which is specially cleaned. The refrigerant is flammable and inodorous. Furthermore, it can lead to explosion under certain conditions. But the flammability of the refrigerant is very low. It can be ignited only by fire.
- Compared to common refrigerants, R32 is a nonpolluting refrigerant with no harm to the ozone layer. The influence upon the greenhouse effect is also lower. R32 has got very good thermodynamic features which lead to a really high energy efficiency. The units therefore need a less filling.

### **WARNING:**

Do not use means to accelerate the defrosting process or to clean, other than those recommended by the manufacturer. Should repair be necessary, contact your nearest authorized Service Centre.

Any repairs carried out by unqualified personnel may be dangerous.

The appliance shall be stored in a room without continuously operating ignition sources. (for example: open flames, an operating gas appliance or an operating electric heater.)

Do not pierce or burn.

Appliance shall be installed, operated and stored in a room with a floor area larger than 4m<sup>2</sup>.

Appliance filled with flammable gas R32. For repairs, strictly follow manufacturer's instructions only.

Be aware that refrigerants do not contain odour.

Read specialist's manual.

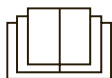

## Precautions

### Warning

This appliance can be used by children aged from 8 years and above and persons with reduced physical, sensory or mental capabilities or lack of experience and knowledge if they have been given supervision or instruction concerning use of the appliance in a safe way and understand the hazards involved. Children shall not play with the appliance.

Cleaning and user maintenance shall not be made by children without supervision.

The air conditioner should be installed in accordance with national wiring regulation.

Air Conditioner should be properly grounded. Incorrect grounding may cause electric shock.

- Do not connect air conditioner to multi-purpose socket. Otherwise, it may cause fire hazard.
- Do install the air switch. If not, it may cause malfunction.
- Do not spill water on the remote controller otherwise the remote controller may be broken.
- Do not spray water on air conditioner. It may cause electric shock or malfunction.
- Do not extend fingers or objects into air inlet or air outlet. It may cause personal injury or damage.
- Do not step on air conditioner, or put heavy objects. It may cause damage or personal injury.
- Do not block air outlet or air inlet. It may cause malfunction.
- Do disconnect power supply when cleaning air conditioner. Otherwise, it may cause electric shock.
- Do not repair air conditioner by yourself. It may cause electric shock or damage. Please contact dealer when you need to repair air conditioner.
- Maintenance must be performed by qualified professionals. Otherwise, it may cause injury or damage.
- The appliance is not to be used by persons (including children) with reduced physical, sensory or mental capabilities, or lack of experience and knowledge, unless they have been given supervision or instruction.
- Children being supervised not to play with the appliance.

Please install the devices for short-circuit protection and electrical leakage protection when installing the air conditioner.

According to the local safety regulations, use qualified power supply circuit and circuit break.

### Working temperature range

※ Operating Temperature Range		
	Indoor side DB/WB(°C)	Outdoor side DB/WB(°C)
Maximum cooling	32/23	43/-
Maximum heating	27/-	24/18

The operating temperature range (outdoor temperature) for cooling only unit is 18°C~ 43°C; for heat pump unit is -7°C~ 43°C.

# ● Installation

## Installation precaution:

Window type conditioner is so valuable and the improper installation of it will cause a lot of damage! Please associate the professional technician to install the unit and don't install it by yourself. Otherwise, we are not responsible for the damage like this.



## Location:

- The condensation water must be drained away conveniently.
- Install air conditioner unit far away from TV set or radio etc. to avoid disturbing video or voice.
- In salt and coastal area or place where is near thermal springs and polluted by sulphurous gas, or other special areas, please contact the seller before use.
- Avoid a place where is possible for inflammable gas to leak out.
- Avoid other heat sources or direct sun light.
- Avoid a place where is easy for children to touch.
- Don't use the unit in the immediate surroundings of a laundry, a bath, a shower or a swimming pool.
- For window type air conditioner with remote control, install in a location where is strong electromagnetic disturbance, you should contact the seller in advance to avoid the malfunction in use.

## How to install:

- Choose a location where there are no any obstacle surrounding the unit, and the plug is accessible.
- Prepare the installation hole slightly bigger than unit size.
- Choose the installation space according to the following diagram.

The distance of obstructions from window unit inside should be upper 300mm, lower 1500mm, left 500mm, right 500mm, front 1500mm.

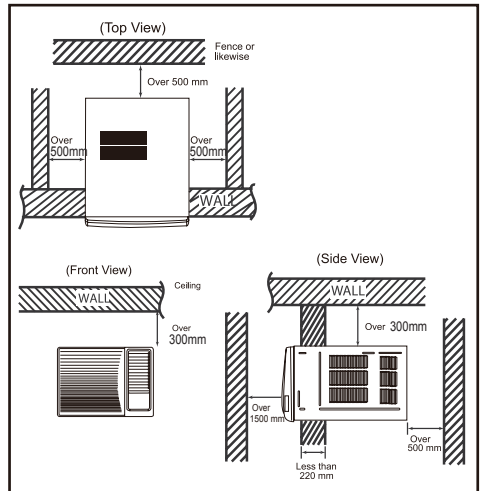

## Installation procedure:

- 1) Remove the sticker from the front panel.
- 2) Put the unit into the installation hole.
  - When installing the unit, it should be slanted down to the back to avoid the enlargement of noise or vibration. (Slant between 6-10mm.) (Shown at right figure.)
  - The installation place should be strong enough to avoid the enlargement of noise or vibration.
- 3) Fill up sews in the cabinet with sponge or foam.

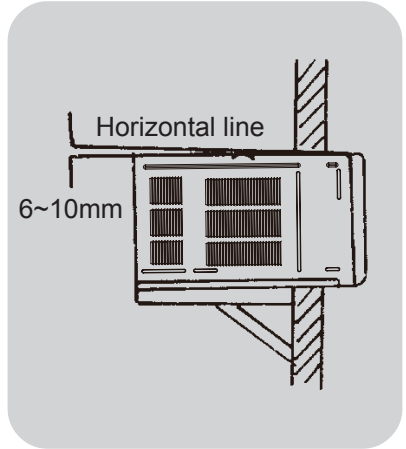

## Installation assistance:

- Use iron support  
The installation hole should be strong enough to support the air conditioner. If it cannot, iron support has to be used outdoors. Iron support should be fixed on the building (Shown at right figure.)
- Use sunshade board  
Air conditioner should avoid anything to be dropped into it and avoid direct sunshine. If there is no cover on it, you should contact the seller for installing the sunshade board. When installing the sunshade board, don't let it block the air inlet at the side grille.

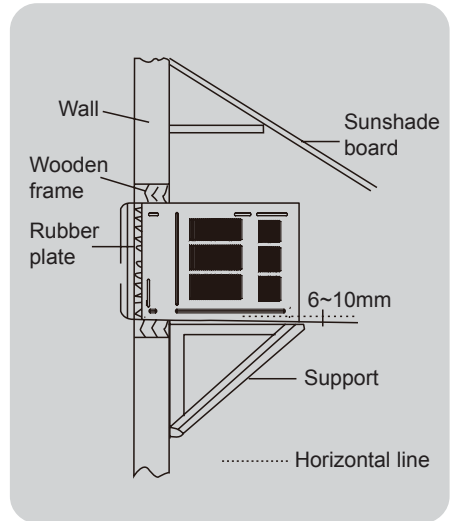

## Drain water :

Drain pan and drain hose need to be installed before using. Drain hose is not included in the products, you need to purchase it locally to satisfy your particular needs. Use the following procedure to install drain pan and drain hose.

1. Slide out the chassis from the cabinet.
2. Install the drain pan to the corner of the cabinet with 2 screws.
3. Connect the drain hose to the outlet on the drain pan bottom.
4. Slide the chassis into its original place in the cabinet.

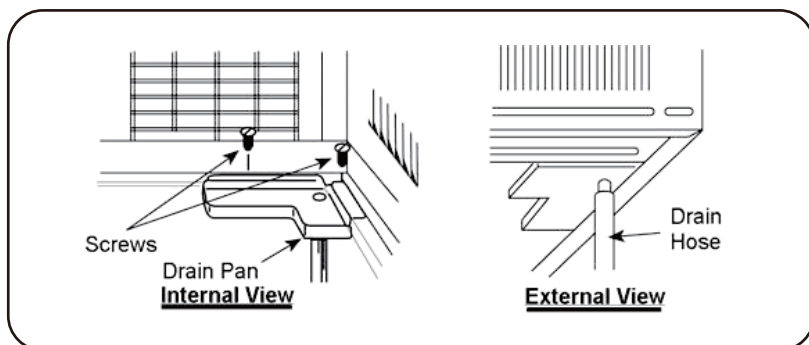

To get the maximum cooling efficiency, the air conditioner is designed to splash the condensation water on the condenser coil. If the splashing sound annoys you, you can remove the rubber plug from the chassis to lower the noise, which also causes a bit of performance loss.



## ● Notes for installation

### Remove

Before removing air conditioner to the other place, you should contact the seller firstly. Then it must be done under the direction of the professional technician. In addition, the charge of this must be paid.

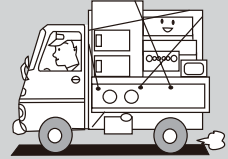

### Noise

- Install in a location where is firm enough to avoid the enlargement of noise and vibration.
- Don't put anything in front of the outlet of outdoor unit to avoid increasing noise.
- Be sure that hot air or noise will not inconvenience neighbors.
- Please contact the seller as soon as there is strange noise during operation.
- Please use the safety support.



### Electric wiring

- Must connect with ground reliably.
- The exclusive circuit must be used. But removable socket can't be used because poor contact of it can cause over heat or fire.
- Don't pull the power cord strongly.
- In fixed circuit, there must be electricity leakage protection switch and leakage current is less than 30mA.
- Connecting method between air conditioners and power cord and interconnecting method of each individual element with one another should accord with wiring diagram on the unit.
- The air conditioner should be installed in accordance with national wiring regulation.
- An all-pole disconnection switch having a contact separation of at least 3mm in all poles should be connected in fixed wiring.
- Air switch (thermal-magnetic breaker) should be installed in the circuit.
- If the supply cord is damaged, it must be replaced by the manufacturer or your dealer or a qualified person to avoid a hazard.
- All The dectrical work must be done according to the local wiring regulations.



# ● Function

## Introduction

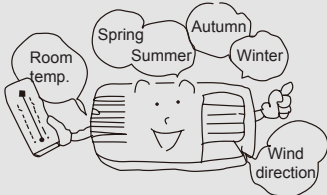

Window type room air conditioners can regulate the room temperature and dry the room. It is convenient for your work, study and life. It can be widely used in residence, shop, hotel, office, library and laboratory, and so on.

### Cooling in summer

In hot summer, Air conditioner can cool down the room air by transferring heat out.

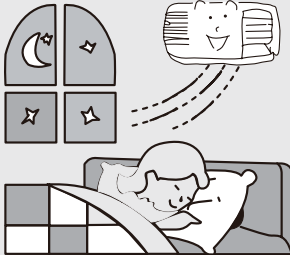

### Dehumidifying in rainy or humid season

Without reducing the room temp., air conditioner can dehumidify and make the room air dry and comfortable.



### Heating in winter

(Only for heat unit)

In cold winter, Air conditioner can heat up room air.



## ● Power requirement

Rated voltage :



- The electric components will be damaged when the voltage is too high. If the voltage is too low, the compressor will vibrate violently to damage the refrigerant system and easily cause the compressor and electric components not work.

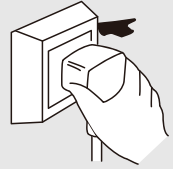

ASW-09BI, ASW-12BI: 230V~ 50Hz

The ground must be connected.



- Special socket must be used. Furthermore, the socket and wiring must conform to the wiring regulations. And the earthing method must be reliable.
- In fixed circuit, there must be electricity leakage protection switch of enough power capacity and air switch with enough space.



**Earth wire** To ensure the reliable earthing, please do not connect earth wire to the following places:

Water pipe

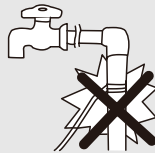

## ● Part identification

Panel outlook picture, just for reference, please take the real unit as standard.

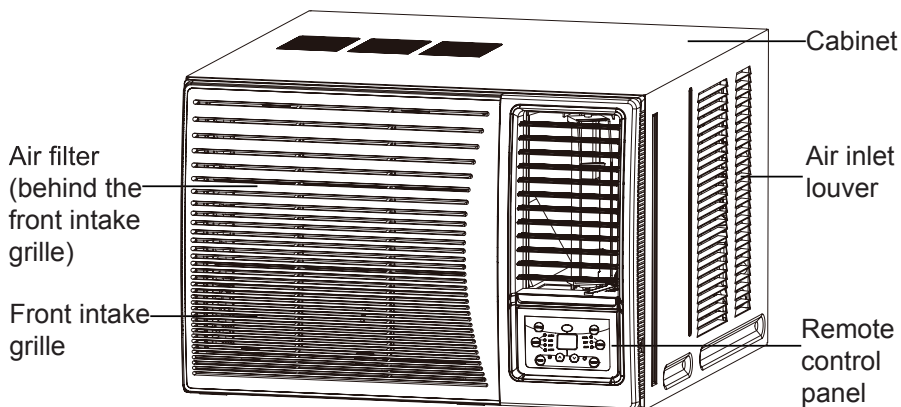

### Air direction adjustment

#### Vertical airflow direction vane

(Airflow direction adjustment up and down).

The vertical airflow direction vane is controlled by positioning the vane to discharge the air upwards, downwards or straight out.

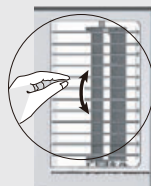

# ● Remote control operation procedure

## Buttons on remote controller

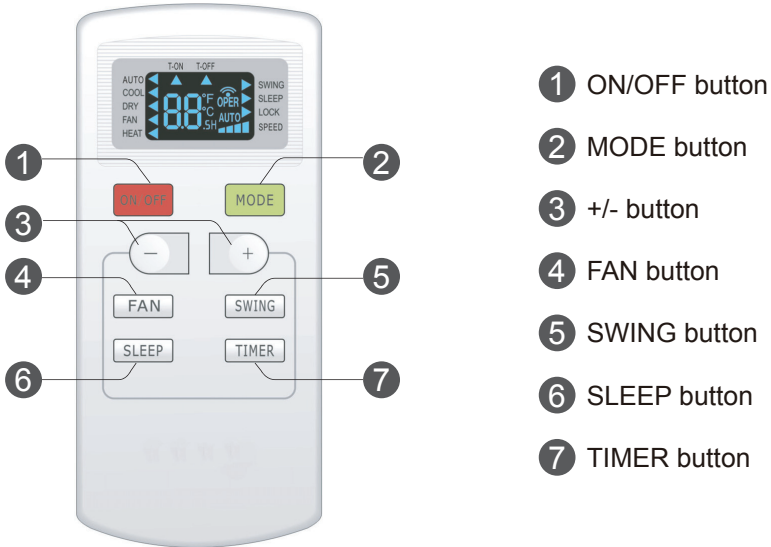

- ① ON/OFF button
- ② MODE button
- ③ +/- button
- ④ FAN button
- ⑤ SWING button
- ⑥ SLEEP button
- ⑦ TIMER button

## Introduction for icons on display screen

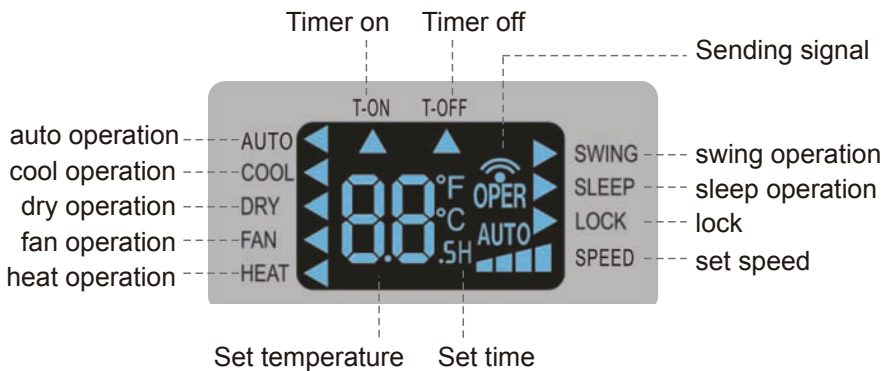

# Introduction for buttons on remote controller

## Note:

- This is a general use remote controller, it could be used for the air conditioners with multifunction; For some function, which the model doesn't have, if press the corresponding button on the remote controller that the unit will keep the original running status.
- When power is connected(stand by condition), you can operate the air conditioner through the remote controller.
- When unit is on, each time you press the button on remote controller, the sending signal icon "📶" on the display of remote controller will blink once. If the air conditioner gives out a beep sound, it means the signal has been sent.
- When unit is off, set temperature will be displayed on the remote controller (If the light of indoor unit display is turned on, the corresponding icon will be displayed); When unit is on, it will display the icon of the on-going function.

## 1 ON/OFF button

Press this button to turn unit on/off.

## 2 MODE button

Pressing this button once can select your required mode circularly as below (the corresponding icon "◀" will be lit up after the mode is selected):



- When selecting auto mode, air conditioner will operate automatically according to ambient temperature. Set temperature can't be adjusted and won't be displayed either. Press FAN button to adjust fan speed.
- When selecting cool mode, air conditioner will operate under cool mode. Then press + or - button to adjust set temperature. Press FAN button to adjust fan speed.
- When selecting dry mode, air conditioner will operate at low fan speed under dry mode. In dry mode, fan speed can't be adjusted.
- When selecting fan mode, air conditioner will operate in fan mode only. Then press FAN button to adjust fan speed.
- When selecting heat mode, air conditioner will operate under heat mode. Then press + or - button to adjust set temperature. Press FAN button to adjust fan speed. (Cooling only unit can't receive heating mode signal. If set HEAT mode by remote controller, press ON/OFF button can't turn on the air conditioner.)

## 3 + / - button

- Pressing + or - button once will increase or decrease set temperature by 1°F(°C). Hold + or - button for 2s, set temperature on remote controller will change quickly. Release the button after your required set temperature is reached.
- When setting Timer On or Timer Off , press + or - button to adjust the time.(See TIMER Button for setting details)

# Introduction for buttons on remote controller

## 4 FAN button

Pressing this button can select fan speed circularly as: AUTO, SPEED 1 (▲), SPEED 2 (▲▲), SPEED 3 (▲▲▲), SPEED 4 (▲▲▲▲) (unavailable in this air conditioner. Speed 4 is the same with speed 3.).

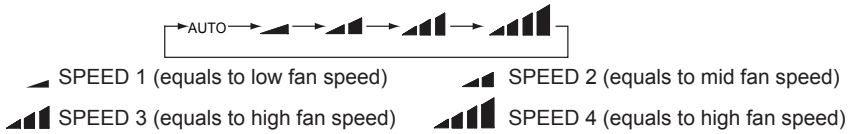

### Note:

- Under Auto speed, air conditioner will select proper fan speed automatically according to ambient temperature.
- Fan speed can't be adjusted under Dry mode.

## 5 SWING button

Press this button to turn on left & right air swing.

## 6 SLEEP button

Under Cool, Heat mode, press this button to turn on Sleep function. Press this button to cancel Sleep function. Under Fan, Dry and Auto mode, this function is unavailable.

## 7 TIMER button

- When unit is on, press this button to set Timer Off. T-OFF and H icon will be blinking. Within 5s, press + or - button to adjust the time for Timer Off. Pressing + or - button once will increase or decrease the time by 0.5h. Hold + or - button for 2s, time will change quickly. Release the button after your required set time is reached. Then press TIMER button to confirm it. T-OFF and H icon will stop blinking.
- When unit is off, press this button to set Timer On. T-ON and H icon will be blinking. Within 5s, press + or - button to adjust the time for Timer On. Pressing + or - button once will increase or decrease the time by 0.5h. Hold + or - button for 2s, time will change quickly. Release the button after your required set time is reached. Then press TIMER button to confirm it. T-ON and H icon will stop blinking.
- Cancel Timer On/Off: If Timer function is set up, press TIMER button once to review the remaining time. Within 5s, press TIMER button again to cancel this function.

---

# Introduction for buttons on remote controller

## Note:

- Range of time setting is: 0.5~24h
- The interval between two motions can't exceed 5s, otherwise the remote controller will exit setting status.

## Function introduction for combination buttons

### Child lock function

Press "+" and "-" buttons simultaneously can turn on or turn off child lock function. When child lock function is started up, LOCK indicator on remote controller is ON. If you operate the remote controller, remote controller won't send signal.

### Temperature display switchover function

Under OFF status, press "-" button and "MODE" button simultaneously can switch between °C and °F.

## Operation guide

1. After putting through the power, press "ON/OFF" button on remote controller to turn on the air conditioner.
2. Press "MODE" button to select your required mode: AUTO, COOL, DRY, FAN, HEAT.
3. Press "+" or "-" button to set your required temperature. (Temperature can't be adjusted under auto mode).
4. Press "FAN" button to set your required fan speed: auto, low, medium and high speed.



# Replacement of batteries in remote controller

1. Press the mark “” on back cover of batteries box cover for remote controller with fingers as shown in the fig, and then remove the batteries box cover along the arrow direction.
2. Replace with two #7 (AAA 1.5V) dry batteries. Make sure positions for “+” pole and “-” pole are correct.
3. Reinstall batteries box cover.

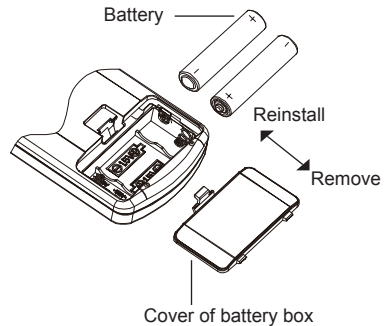

## **NOTICE**

- The distance between signal sender and receiving window should be no more than 8m, and there should be no obstacles between them.
- As the signal will be interfered in the room with electronic fluorescent lamp, conversion fluorescent lamp or wireless phone, please get closer to the air conditioner when using the remote controller.
- Replace new batteries of the same model when replacement is required.
- When you don't use remote controller for a long time, please take out the batteries.

## Remote control panel

### Note:

If wireless remote controller is lost, open the surface panel and operate manually.

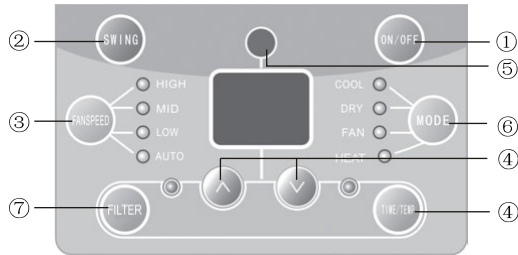
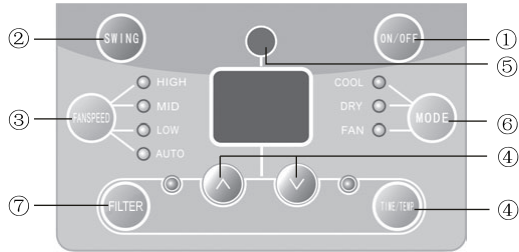

- 1 POWER BUTTON**  
Operation starts when pressing this button, and stops when pressing this button again.
- 2 SWING BUTTON**  
Activate the automatic air swing function.
- 3 FAN SPEED BUTTON**  
Select the fan speed HIGH, MID, LOW and AUTO in sequence.
- 4 TEMP/TIMER BUTTON**  
Press the ▲ keypad to increase the set (operating) temperature of the unit and Press the ▼ keypad to decrease the set (operating) temperature of the unit. The temperature setting range is from 16~30°C  
Timer can be set by pressing ▲/▼ button. Timer can be set in 0.5hour increments between 1 and 10 hours, or in 1hour increments for 10 hours or above after each push on ▲ or ▼ button.
- 5 SIGNAL RECEIVER**
- 6 MODE BUTTON**  
Select the operation mode, AUTO, HEAT, COOL, FAN, DRY (for reverse cycle model) or COOL, FAN, DRY (for cooling only model).
- 7 FILTER BUTTON**  
This feature is a reminder to clean the Air Filter (See Care and Cleaning) for more efficient operation and cooling. The LED (light) will illuminate after 250 hours of operation. To reset after cleaning the filter, press the "Check Filter" button and the light will go off.

## ● Operation Tips

### Operation for comfort and economy

Do not overcool the room temperature. This is not good for health and wastes electricity.

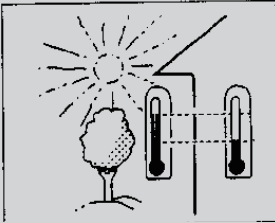

Keep blind or curtains closed. Do not let sunshine enter the room directly when the air condition is in operation.

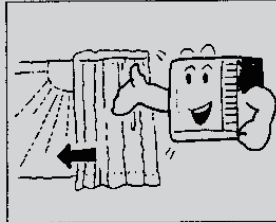

Keep the room temp. uniform. Adjust the vertical and horizontal airflow direction to ensure a uniform temperature in the room. Air can't be discharged to the direction of air-in.

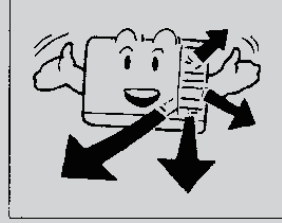

Make sure that the doors and windows are tightly closed. Avoid opening doors and windows as much as possible to keep air conditioning in the room.

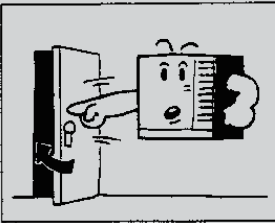

Clean the air filter regularly. Blockages in the air filter reduce dehumidifying effects. Clean the air filter at least once every two weeks.

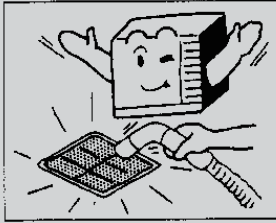

Ventilate the room occasionally. Since windows are kept closed, it is a good idea to open them and ventilate the room now and then. When starting the unit, curtains or windows should be closed to prevent the heat/cool leakage.

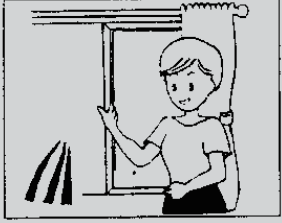

# ● Caution

## Operations for safety and health

- 1) The plug must be accessible after the appliance is positioned.
- 2) Do not use this appliance in the laundry.
- 3) If the power cord is damaged, it must be replaced by the manufacture or its service agent in void of hazard.

- Do not pull out the power cord.
- Damage to the cord may result in serious electric shocks

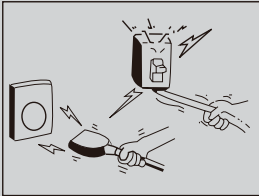

- Do not use the air conditioner for other purposes except for cooling the room.
- Do not use the air conditioner for other purposes such as drying clothes, preserving foods, or cultivating vegetables.



- Do not block the air intake and outlet vents. This causes lowered performance and irregular operation.
- Do not insert sticks or other objects into these vents as it is dangerous to touch the electric components and the fan.



Select the most appropriate temperature. Pay attention to adjust the temperature to suit the conditions. Rooms occupied by infants, the elderly, or the sick should be kept at an appropriate temperature.

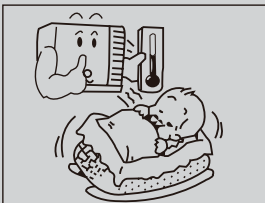

Do not use heating apparatuses in the vicinity. The air conditioner's plastic parts will melt if exposed to excessive heat.

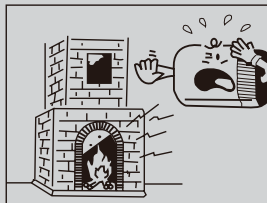

Avoid exposing the body directly to a continuous unidirectional air flow for long periods. This is not recommended for health reason.

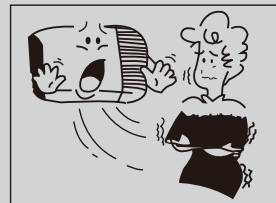

Always wait at least 3 minutes before switching the air conditioner on again after you have switched it off during cooling or heating.



Please notice that the unit is filled with flammable gas R32. Inappropriate treatment of the unit involves the risk of severe damages of people and material. Details to this refrigerant are found in chapter "refrigerant".

Appliance shall be installed, operated and stored in a room with a floor area larger than  $4\text{m}^2$ .

## Care and maintenance

Always turn off the air conditioner and main power supply before cleaning to ensure safety.

### Cleaning unit

1. Cut power of f before cleaning.

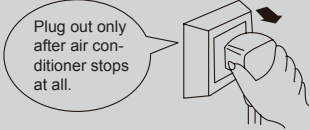

2. Use soft cloth when cleaning cabinet. If the cabinet is very dirty, dip cloth into warm water below 40°C, dry the cloth and then rub off the dirt.



3. Don't use gas, benzene, solvent, wash, chemical solvent, etc. for cleaning.



4. Do not splash water directly into indoor unit, in which there are micro-computer and circuit plate, they must not bedrenched with water.



### Air filter

The air filter behind the intake grille should be washed at least once every two weeks or as often as it needs cleaning.

How to clean the air filter:

1. To remove the air intake grille, grasp the tab on the filter and pull to take out.

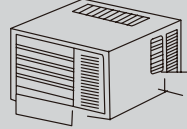

2. Vacuum the filter on the dusty side to remove light dust.

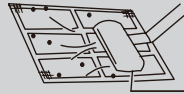

Vacuum cleaner

3. Wash the filter, cleaner side up under gently flowing water to wash out accumulated dust and lint.



4. If the filter is very dirty, use a mild household detergent in the wash water.



Let the filter dry thoroughly before reinstalling it. If necessary, please ask the professional personnel to clean it.

- \* Check earth wire

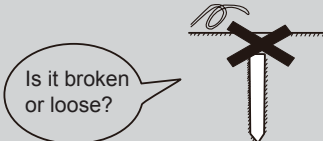





- \* Check if air inlet and outlet of outdoor unit are blocked or not.



## ● Troubleshooting guide

Please check the following items before asking for repair, it saves your time and money.

Fault phenomenon	Trouble-shooting
<p>Air conditioner dose not operate at all.</p> 	<ul style="list-style-type: none"> <li>• Is there a power failure?</li> <li>• Is the plug out?</li> <li>• Is power fuse or switch off ?</li> <li>• Whether the voltage is too high or too low?</li> </ul>
<p>Cool or heat efficiency is not good.</p> 	<ul style="list-style-type: none"> <li>• Is air inlet or outlet locking?</li> <li>• Is there any other heat /cool source in room?</li> <li>• Are air filters dirty very much?</li> <li>• Is indoor fan speed set at LOW?</li> <li>• Maybe the room is too hot/cool when the unit is started.</li> </ul>
<p>Foggy air flows out.</p> 	<ul style="list-style-type: none"> <li>• At COOL mode operation, sometimes there is foggy air flowing out of indoor unit, this is because the room humid air has been cooling rapidly.</li> <li>• The unit is normal while the indoor outlet is sending out some odor, because the inlet air may be mixed with the smell of furniture and smoke.</li> </ul>
<p>The air conditioner operation is noisy.</p> 	<ul style="list-style-type: none"> <li>• For a noise that sounds like water flowing: This is the sound of freon flowing inside the air conditioner unit.</li> <li>• For a noise that sounds like a shower: This is the sound of the dehumidifying water being processed inside the air conditioner unit.</li> </ul>
<p>It seems that condensation is leaking from air conditioner.</p>	<ul style="list-style-type: none"> <li>• Condensation occurs when the airflow from the air conditioner cools the warm room air.</li> </ul>
<p>Air conditioner dose not operate for about 3 minutes when restart.</p>	<ul style="list-style-type: none"> <li>• This is to protect the mechanism.</li> <li>• Wait about three minutes and operation will begin.</li> </ul>

Malfunction code	Solution
H1	Means defrosting status. It's the normal phenomenon.
E2	Please contact professional person to deal with it.
H5	Please contact professional person to deal with it.
E5	Please contact professional person to deal with it.
H4	Please contact professional person to deal with it.
E4	Please contact professional person to deal with it.
H3	Please contact professional person to deal with it.
L9	Please contact professional person to deal with it.
H5	Please contact professional person to deal with it.
PL	Please contact professional person to deal with it.
PH	Please contact professional person to deal with it.
HC	Please contact professional person to deal with it.
LP	Please contact professional person to deal with it.
Fo	Please contact professional person to deal with it.
F3	Please contact professional person to deal with it.
F4	Please contact professional person to deal with it.
F5	Please contact professional person to deal with it.
F0	Please contact professional person to deal with it.
E6	Please contact professional person to deal with it.
F1	Please contact professional person to deal with it.
F2	Please contact professional person to deal with it.
U7	Please contact professional person to deal with it.

Note: If there're other malfunction codes, please contact qualified professionals for service.

**Immediately stop all operations and plug out, please contact your dealer in the following situations.**

- Operation starts or stops abnormally.
- Power fuse or switch often breaks.
- Carelessly splash water or something into air conditioner.
- Electrical lines are much hot or lines cover breaks.
- Other strange situations.



## ● After service

- If your air conditioner has the questions of quality or anything else, please contact the service center.



## ● Safety operation of flammable refrigerant

### ● Qualification requirement for installation and maintenance man

1. All the work men who are engaging in the refrigeration system should bear the valid certification awarded by the authoritative organization and the qualification for dealing with the refrigeration system recognized by this industry. If it needs other technician to maintain and repair the appliance, they should be supervised by the person who bears the qualification for using the flammable refrigerant.
2. It can only be repaired by the method suggested by the equipment's manufacturer.

### ● Installation notes

1. The air conditioner is not allowed to use in a room that has running fire ( such as fire source, working coal gas ware, operating heater).
2. The air conditioner must be installed in a room that is larger than the minimum room area.  
The minimum room area is shown on the nameplate or following table.
3. Leak test is a must after installation.

table- Minimum room area (m<sup>2</sup>)

Minimum room area (m <sup>2</sup> )	Charge amount (kg)	≤1.2	1.3	1.4	1.5	1.6	1.7	1.8	1.9	2	2.1	2.2	2.3	2.4	2.5
	floor location	/	14.5	16.8	19.3	22	24.8	27.8	31	34.3	37.8	41.5	45.4	49.4	53.6
window mounted	/	5.2	6.1	7	7.9	8.9	10	11.2	12.4	13.6	15	16.3	17.8	19.3	
	wall mounted	/	1.6	1.9	2.1	2.4	2.8	3.1	3.4	3.8	4.2	4.6	5	5.5	6
	ceiling mounted	/	1.1	1.3	1.4	1.6	1.8	2.1	2.3	2.6	2.8	3.1	3.4	3.7	4

### ● Maintenance notes

1. Check whether the maintenance area or the room area meet the requirement of the nameplate.  
- It's only allowed to be operated in the rooms that meet the requirement of the nameplate.
2. Check whether the maintenance area is well-ventilated.  
- The continuous ventilation status should be kept during the operation process.
3. Check whether there is fire source or potential fire source in the maintenance area.  
- The naked flame is prohibited in the maintenance area; and the "no smoking" warning board should be hanged.
4. Check whether the appliance mark is in good condition.  
- Replace the vague or damaged warning mark.

## ● **Welding**

1. If you should cut or weld the refrigerant system pipes in the process of maintaining, please follow the steps as below
  - a. Shut down the unit and cut power supply
  - b. eliminate the refrigerant
  - c. vacuuming
  - d. clean it with N<sub>2</sub> gas
  - e. cutting or welding
  - f. carry back to the service spot for welding
2. The refrigerant should be recycled into the specialized storage tank.
3. Make sure that there isn't any naked flame near the outlet of the vacuum pump and it's well-ventilated.

## ● **Filling the refrigerant**

1. Use the refrigerant filling appliances specialized for R32. Make sure that different kinds of refrigerant won't contaminate with each other.
2. The refrigerant tank should be kept upright at the time of filling refrigerant.
3. Stick the label on the system after filling is finished (or haven't finished)
4. Don't overfilling.
5. After filling is finished, please do the leakage detection before test running; another time of leak detection should be done when it's removed.

## ● **Safety instructions for transportation and storage**

1. Please use the flammable gas detector to check before unload and open the container.
2. No fire source and smoking.
3. According to the local rules and laws.



# RÜCKNAHME ELEKTRISCHER ABFÄLLE

---



Das aufgeführte Symbol am Produkt oder in den Beipackunterlagen bedeutet, dass die gebrauchten elektrischen oder elektronischen Produkte nicht gemeinsam mit Hausmüll entsorgt werden dürfen. Zur ordnungsgemäßen Entsorgung geben Sie die Produkte an bestimmten Sammelstellen kostenfrei ab. Durch ordnungsgemäße Entsorgung dieses Produktes leisten Sie einen Beitrag zur Erhaltung natürlicher Ressourcen und Vorbeugung negativer Auswirkungen auf die Umwelt und menschliche Gesundheit als Konsequenzen einer falschen Entsorgung von Abfällen. Weitere Details verlangen Sie von der örtlichen Behörde oder der nächstliegenden Sammelstelle.

## INFORMATIONEN ZUM KÄLTEMITTEL

---

Diese Anlage enthält fluorisierte Treibhausgase, die im Kyoto-Protokoll mit einbezogen sind. Die Instandhaltung und die Entsorgung müssen durch qualifiziertes Personal durchgeführt werden.

Kältemitteltyp: R32

Kältemittelmenge: siehe Typenschild.

GWP-Wert: 675

GWP = Global Warming Potential (Treibhauspotenzial)



Die Anlage wird mit brennbarem Kältemittel R32 gefüllt.

Im Falle von Störung, qualitätsbezogenen oder anderen Problemen trennen Sie die Anlage von der Stromversorgung, und rufen Sie bitte den örtlichen Händler oder den autorisierten Kundendienst.

**Notrufnummer: 112**

## HERSTELLER

---

SINCLAIR CORPORATION Ltd.

1-4 Argyll St.

London W1F 7LD

Great Britain

[www.sinclair-world.com](http://www.sinclair-world.com)

Die Anlage wurde in China hergestellt (Made in China).

## VERTRETER, TECHNISCHE UNTERSTÜTZUNG

---

NEPA spol. s r.o.

Purkyňova 45

612 00 Brno

Tschechische Republik

Tel.: +420 541 590 140

Fax: +420 541 590 124

[www.sinclair-solutions.com](http://www.sinclair-solutions.com)

[info@sinclair-solutions.com](mailto:info@sinclair-solutions.com)

